

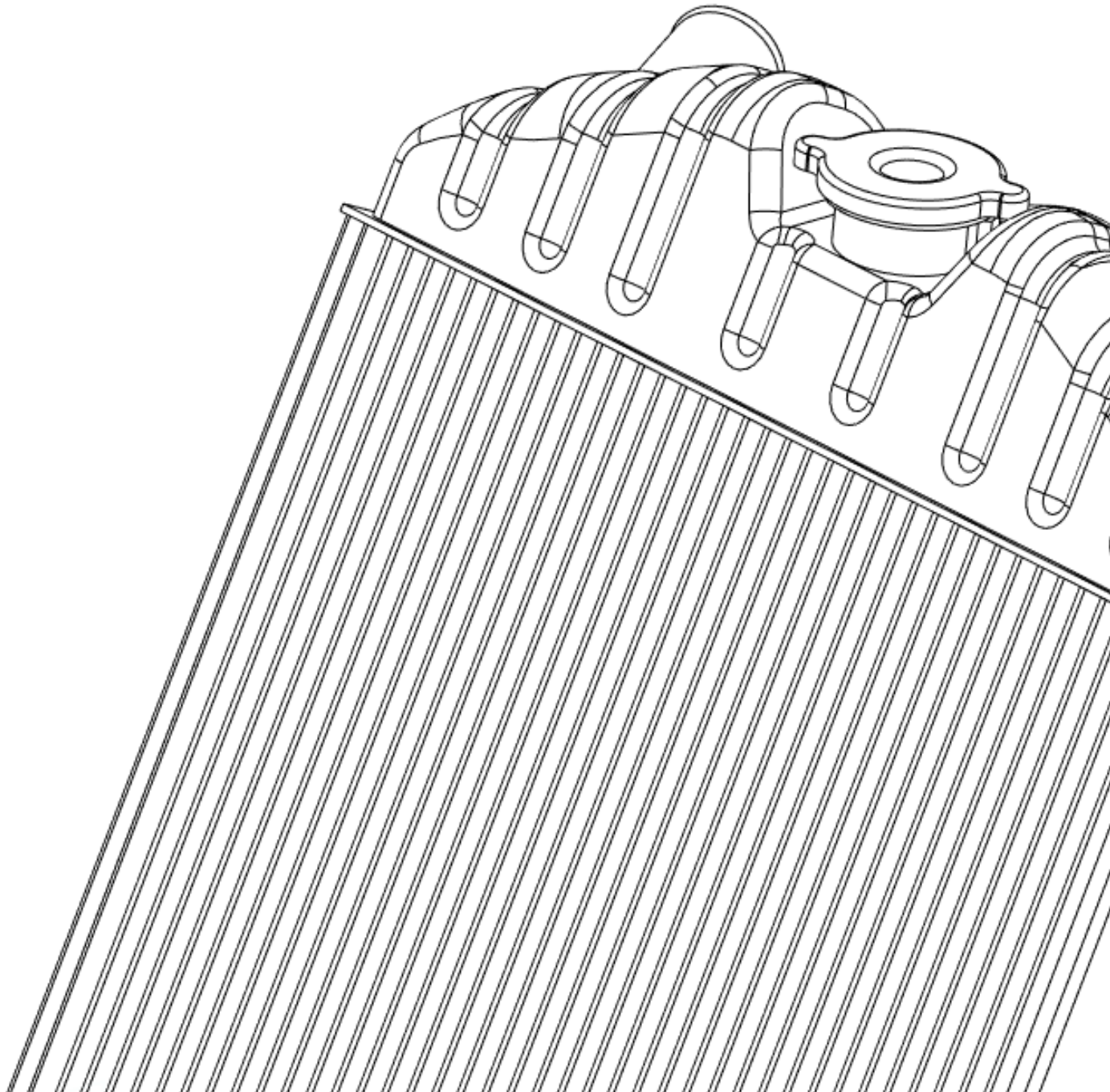

Core Selection Catalogue

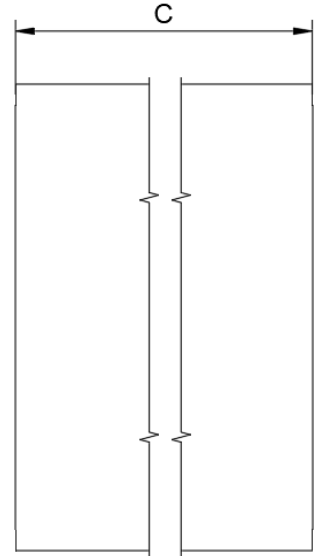

TUBE PROFILES

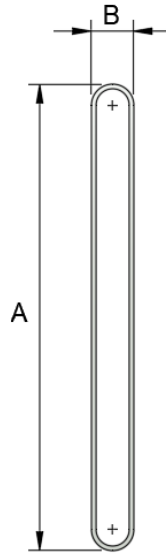
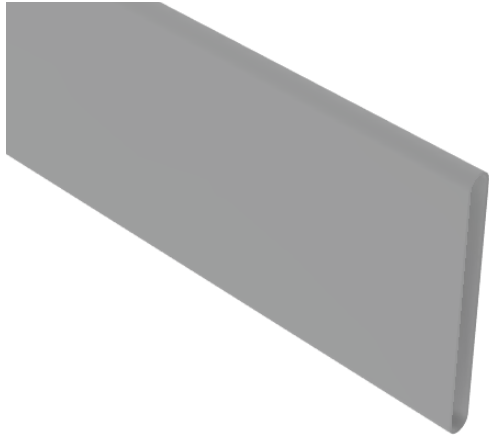

Type	A	B	C
	Choice of		Length
Automotive Water	22 / 26 / 32 / 40	2	Any
Heavy Duty Water	22 / 30 / 45 / 60	4	Any
Oil Cooler	22 / 30 / 45 / 60	4	Any
Intercooler	40 / 50 / 60	7	Any

Sizes in mm

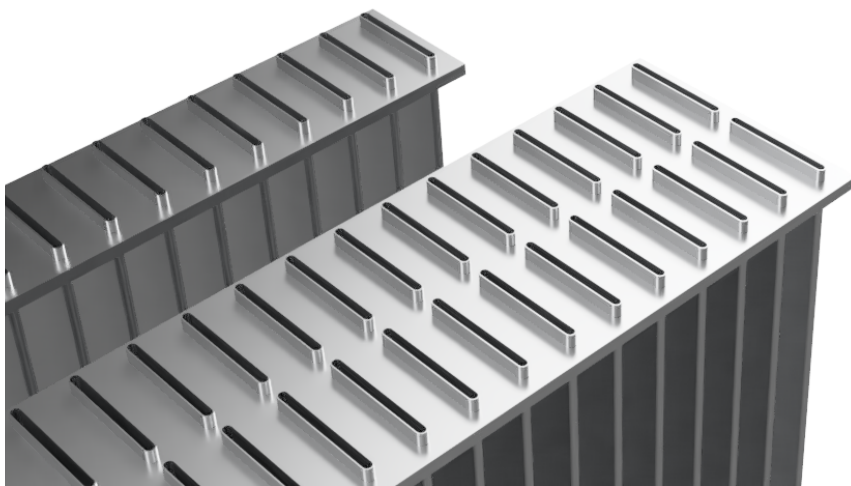

We manufacture single and multi-row cores up to a thickness of 130mm

COOLING FINS

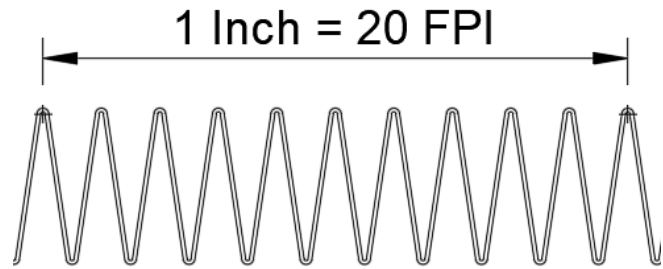

Size	Type	FPI ¹
		Choice of
6	Louvred	8 – 24 (in increments of 1)
7	Dimple Wave	10 - 12
8	Louvred	8 – 24 (in increments of 1)
10	Dimple Wave	8

Sizes in mm

1. FPI – Fins Per Inch

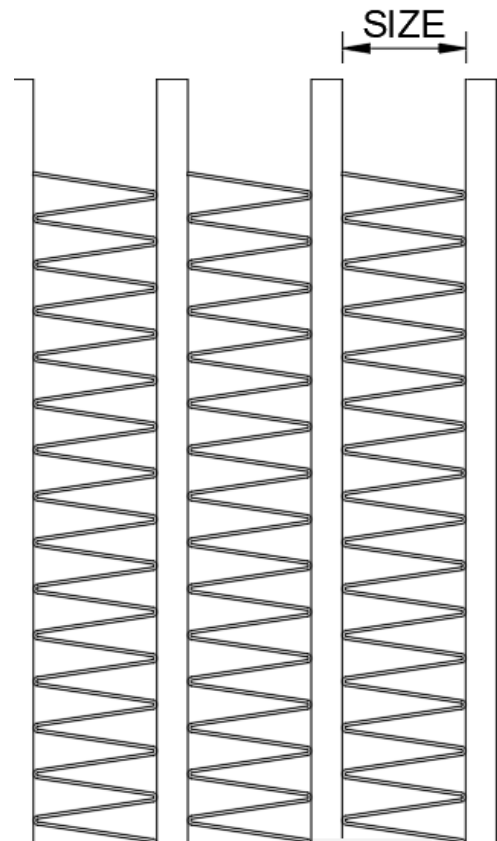
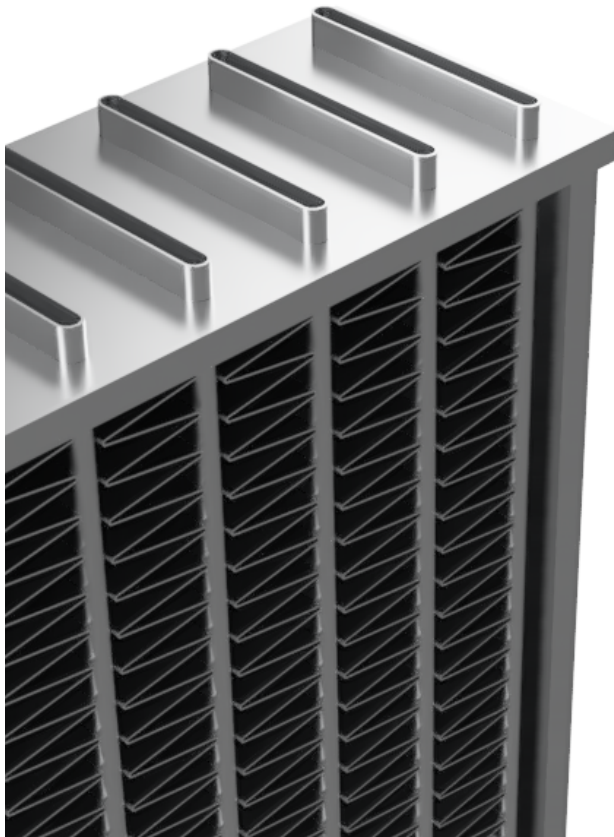

HEADER PLATES

Flat

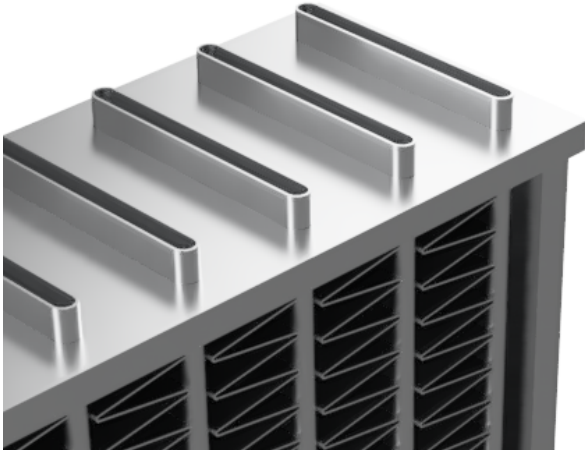

Long Sides Folded – Open Ends

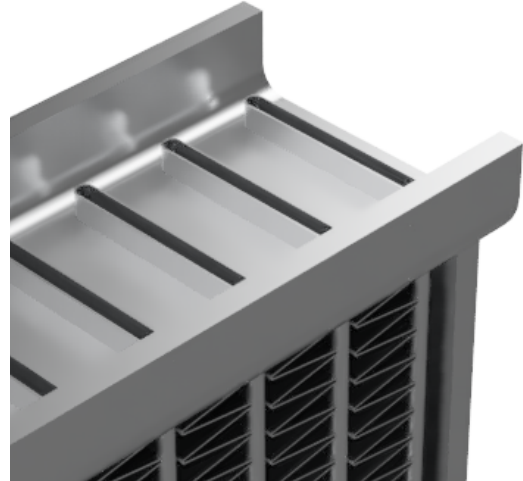

Fully Folded

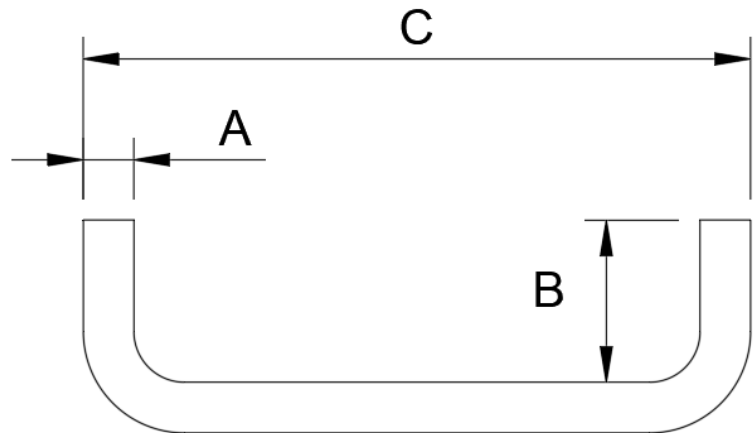
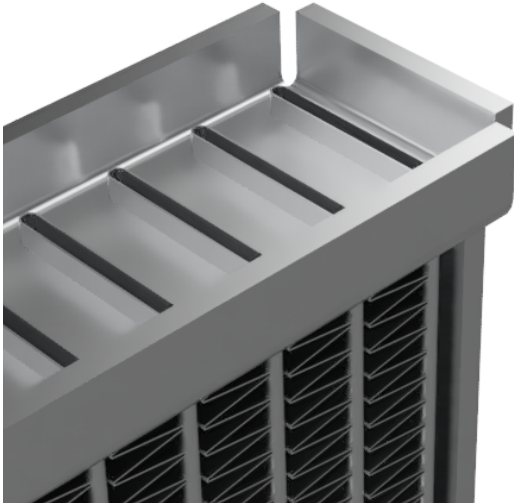

Type	A	B	C	D
	Choice of	Choice of		Length
Flat	1.5 / 2.5 / 3.0 / 5.0	8 / 9 / 10 / 11 / 12	Any	Any
Sides Folded Open Ends	1.5 / 2.5 / 3.0 / 5.0	8 / 9 / 10 / 11 / 12	Any	Any
Fully Folded	1.5 / 2.5 / 3.0 / 5.0	8 / 9 / 10 / 11 / 12	Any	Any

Sizes in mm

SIDE PLATES

Flat

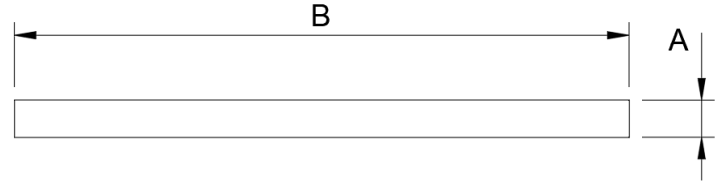
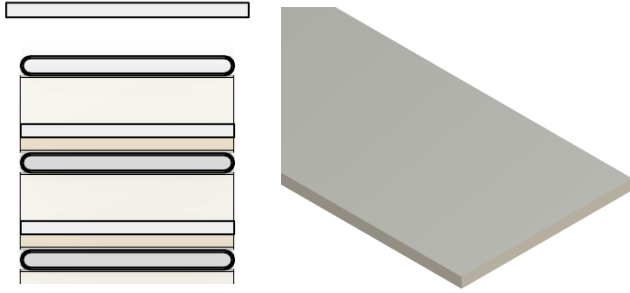

Folded Outwards

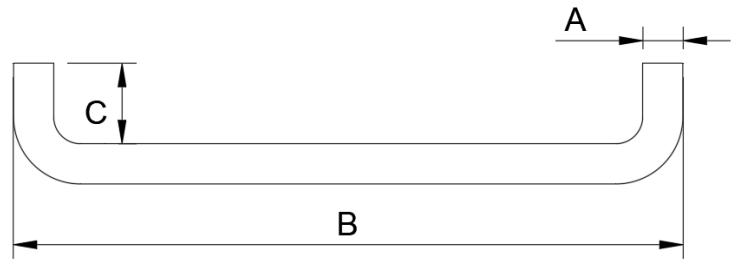
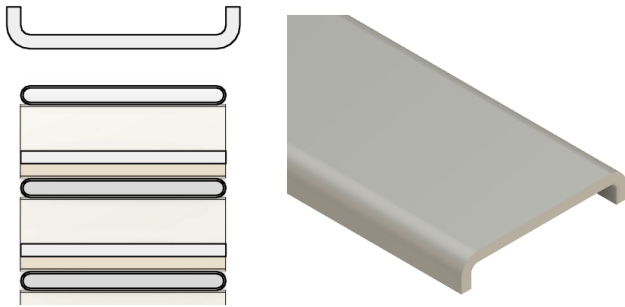

Folded Inwards

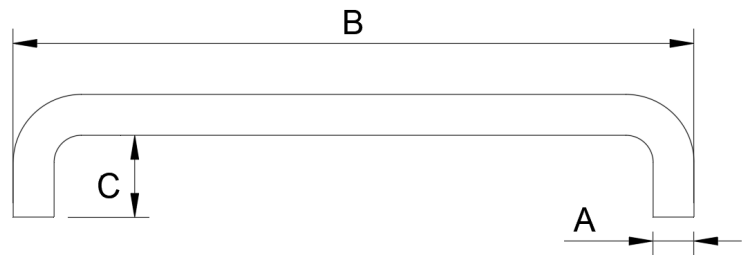
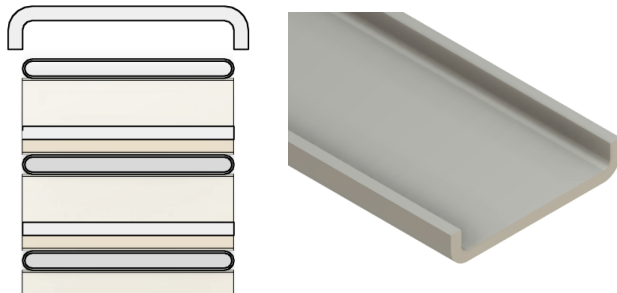

Type	A	B	C	D
	Choice of			Length
Flat	1.5 / 2.0 / 2.5 / 3.0	Any	-	Any
Folded Outwards	1.5 / 2.0 / 2.5 / 3.0	Any	Any	Any
Folded Inwards	1.5 / 2.0 / 2.5 / 3.0	Any	Any	Any

Sizes in mm



STANDARD CORE DEPTHS

Automotive Water	Heavy Duty Water
22	22
26	45
32	60
40	92
50	122
58	
60	
70	
84	
Oil Cooler	Intercooler
22	40
30	50
45	60
50	80
60	92
92	122
122	

Sizes in mm